

CUSTOM TOUCH

INNOVATION ET STABILITÉ
POUR UN RECEVEUR
ESTHÉTIQUE.

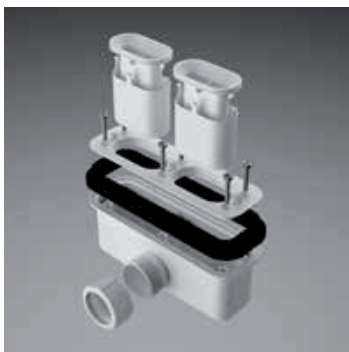

◀ Bonde inspectable avec grand flux d'évacuation et cache-bonde assorti

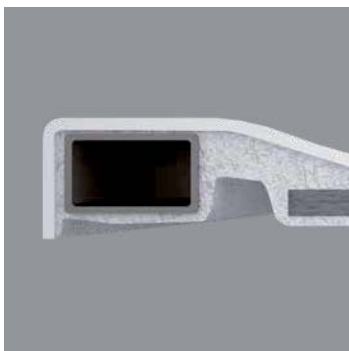

◀ Profilé de renfort en acier (pour receveur hauteur 3,5 cm)



◀ Aspect effet pierre, surface antiglisse et chaude au toucher



Ligne de receveurs de douche robustes et légers à la fois, avec une finition texturée élégante aspect pierre, qui leur confère une sensation agréable au toucher. Des lignes nettes, sobres et seulement 3,5 cm d'épaisseur, avec une possibilité d'installation au ras du sol. Recoupable sur 20 cm.



CUSTOM TOUCH

CUSTOM TOUCH

HAUTEUR 3,5 CM

Bonde incluse, débit 40 l/min
 Indice de résistance à la glissance PN18

ZONE RECOUVPABLE 20 cm



Blanc mat Beige Corda Gris Noir

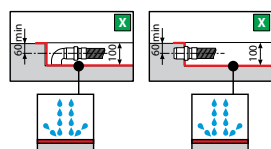
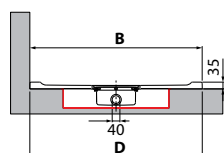
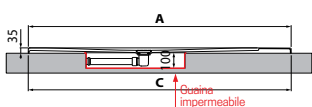
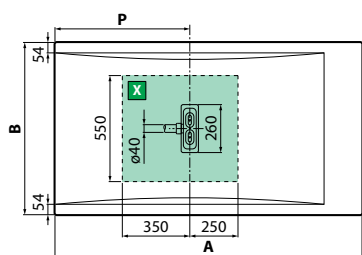

Dimensions				Code	Finition / Prix				
					79	11	27	29	28
	AxB ±2 mm	CxD ±3 mm	P		Blanc mat	Beige	Corda	Gris	Noir
100 x 80	994 x 792	996 x 794	400	CT100804-					
120 x 70	1194 x 692	1196 x 694	500	CT120704-					
120 x 80	1194 x 792	1196 x 794	500	CT120804-					
120 x 90	1194 x 892	1196 x 894	500	CT120904-					
120 x 100	1194 x 992	1196 x 994	500	CT120104-					
140 x 70	1392 x 692	1394 x 694	600	CT140704-					
140 x 80	1392 x 792	1394 x 794	600	CT140804-					
140 x 90	1392 x 892	1394 x 894	600	CT140904-					
160 x 70	1592 x 692	1594 x 694	700	CT160704-					
160 x 80	1592 x 792	1594 x 794	700	CT160804-					
160 x 90	1592 x 892	1594 x 894	700	CT160904-					
180 x 80	1792 x 792	1794 x 794	800	CT180804-					
180 x 90	1792 x 892	1794 x 894	800	CT180904-					

* Dimensions (cm) de la partie supérieure du receveur
 ** Mesure du receveur au sol

INSTALLATION AU NIVEAU DU SOL



UNIQUEMENT POUR 3,5 CM DE HAUTEUR

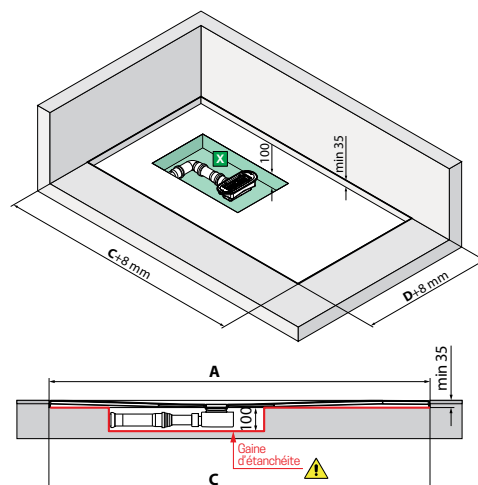

CUSTOM TOUCH

HAUTEUR 12 CM

Bonde incluse, débit 40 l/min

Indice de résistance à la glissance PN18



Blanc mat

Beige

Corda

Gris

Noir

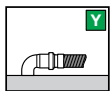
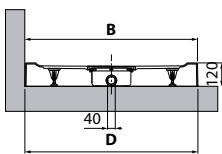
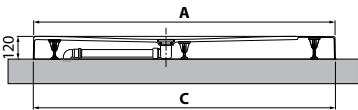
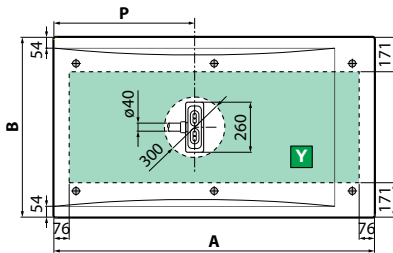

Dimensions				Code	Finition / Prix				
	AxB	CxD	P		79	11	27	29	28
	*± 2 mm	**± 3 mm			Blanc mat	Beige	Corda	Gris	Noir
100 x 80	994 x 792	1000 x 798	400	CT1008011-					
120 x 70	1194 x 692	1200 x 698	500	CT1207011-					
120 x 80	1194 x 792	1200 x 798	500	CT1208011-					
120 x 90	1194 x 892	1200 x 898	500	CT1209011-					
120 x 100	1194 x 992	1200 x 998	500	CT1201011-					
140 x 70	1392 x 692	1398 x 698	600	CT1407011-					
140 x 80	1392 x 792	1398 x 798	600	CT1408011-					
140 x 90	1392 x 892	1398 x 898	600	CT1409011-					
160 x 70	1592 x 692	1598 x 698	700	CT1607011-					
160 x 80	1592 x 792	1598 x 798	700	CT1608011-					
160 x 90	1592 x 892	1598 x 898	700	CT1609011-					
180 x 80	1792 x 792	1798 x 798	800	CT1808011-					
180 x 90	1792 x 892	1798 x 898	800	CT1809011-					

- * Dimensions (cm) de la partie supérieure du receveur
- ** Mesure du receveur au sol

OPTION



Kit de 2 profilés de finition rigides de 195 cm

Code

PRVA195-30

Composition du code Code + Finition = Code produit complet

CUSTOM

TECHNOLOGIE
ET SIMPLICITÉ
RÉUNIES DANS UN
SEUL RECEVEUR.

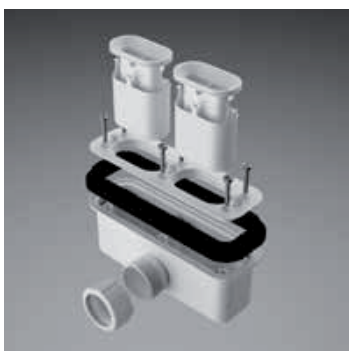

◀ Bonde inspectable avec grand flux d'évacuation et cache-bonde assorti

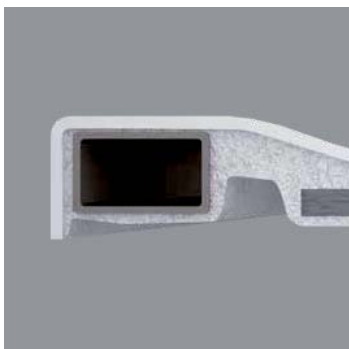

◀ Profilé de renfort en acier (pour receveur hauteur 3,5 cm)



◀ Recoupable pour s'adapter à toutes les exigences architecturales (pour receveur hauteur 3,5 cm)



Receveurs de douche en Sintek aux lignes élégantes. Possibilité d'installation au ras du sol. Recoupable sur 20 cm.



RECEVEURS
DE DOUCHE

CUSTOM

CUSTOM

HAUTEUR 3,5 CM

Bonde incluse, débit 40 l/min
 Indice de résistance à la glissance PN18



Blanc Blanc mat Beige Corda Gris Noir mat

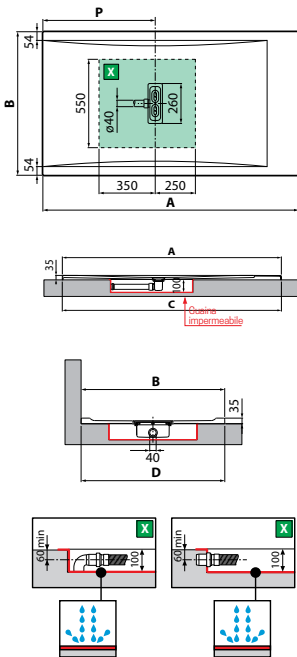

Dimensions		Surface lisse Code	Finition / Prix						Avec antidérapant	Finition / Prix
AxB ± 2 mm	CxD ± 3 mm		P	30	79	11	27	29		
			Blanc	Blanc mat	Beige	Corda	Gris	Noir	Blanc	
100 x 80	994 x 792	996 x 794	400	CU100804-						CU100804A-
120 x 70	1194 x 692	1196 x 694	500	CU120704-						CU120704A-
120 x 80	1194 x 792	1196 x 794	500	CU120804-						CU120804A-
120 x 90	1194 x 892	1196 x 894	500	CU120904-						CU120904A-
120 x 100	1194 x 992	1196 x 994	500	CU120104-						CU120104A-
140 x 70	1392 x 692	1394 x 694	600	CU140704-						CU140704A-
140 x 80	1392 x 792	1394 x 794	600	CU140804-						CU140804A-
140 x 90	1392 x 892	1394 x 894	600	CU140904-						CU140904A-
160 x 70	1592 x 692	1594 x 694	700	CU160704-						CU160704A-
160 x 80	1592 x 792	1594 x 794	700	CU160804-						CU160804A-
160 x 90	1592 x 892	1594 x 894	700	CU160904-						CU160904A-
180 x 80	1792 x 792	1794 x 794	800	CU180804-						CU180804A-
180 x 90	1792 x 892	1794 x 894	800	CU180904-						CU180904A-

* Dimensions (cm) de la partie supérieure du receveur
 ** Mesure du receveur au sol

INSTALLATION AU NIVEAU DU SOL



UNIQUEMENT POUR 3,5 CM DE HAUTEUR

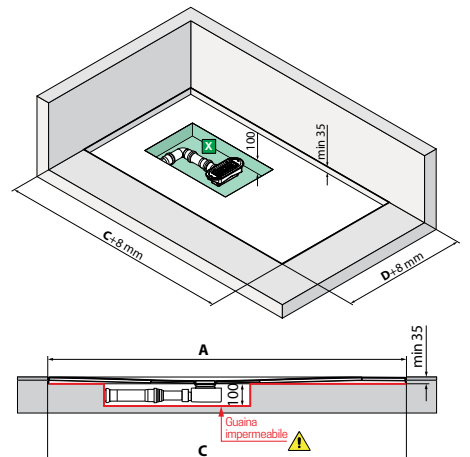

CUSTOM

HAUTEUR 12 CM

Bonde incluse, débit 40 l/min
Indice de résistance à la glissance PN18



Blanc Blanc mat Beige Corda Gris Noir mat

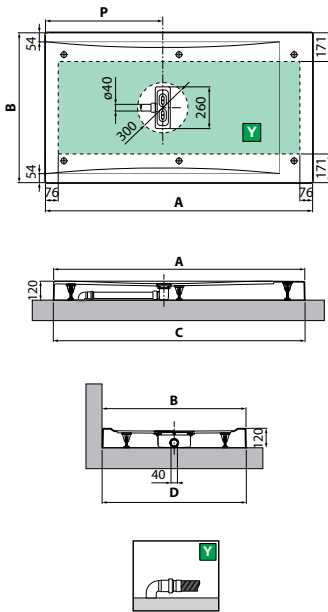

Dimensions		Surface lisse Code	Finition / Prix						Avec antidérapant	Finition Prix
			30	79	11	27	29	28		30
			Blanc	Blanc mat	Beige	Corda	Gris	Noir		Blanc
AxB ±2 CxD ±3 P										
		mm								
100 x 80	994 x 792	1000 x 798	400	CU1008011-					CU1008011A-	
120 x 70	1194 x 692	1200 x 698	500	CU1207011-					CU1207011A-	
120 x 80	1194 x 792	1200 x 798	500	CU1208011-					CU1208011A-	
120 x 90	1194 x 892	1200 x 898	500	CU1209011-					CU1209011A-	
120 x 100	1194 x 992	1200 x 998	500	CU1201011-					CU1201011A-	
140 x 70	1392 x 692	1398 x 698	600	CU1407011-					CU1407011A-	
140 x 80	1392 x 792	1398 x 798	600	CU1408011-					CU1408011A-	
140 x 90	1392 x 892	1398 x 898	600	CU1409011-					CU1409011A-	
160 x 70	1592 x 692	1598 x 698	700	CU1607011-					CU1607011A-	
160 x 80	1592 x 792	1598 x 798	700	CU1608011-					CU1608011A-	
160 x 90	1592 x 892	1598 x 898	700	CU1609011-					CU1609011A-	
180 x 80	1792 x 792	1798 x 798	800	CU1808011-					CU1808011A-	
180 x 90	1792 x 892	1798 x 898	800	CU1809011-					CU1809011A-	

* Dimensions (cm) de la partie supérieure du receveur
** Mesure du receveur au sol

OPTION

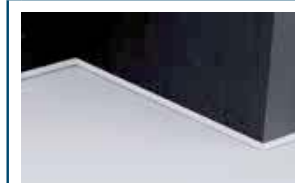

Kit de 2 profilés de finition
rigides de 195 cm

Code

PRVA195-30

Costruzione del codice **Codice** + **Finitura** = Codice prodotto finale