

# DIVINA 35

**BAIGNOIRE RECTANGULAIRE, HAUTEUR DU BORD 3,5 CM**  
**FINITION BLANC BRILLANT OU BLANC MAT, FOND LISSE**

Configurez votre baignoire sur [novellini.fr/yourproduct.html](http://novellini.fr/yourproduct.html)

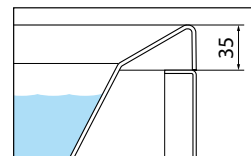

**HAUTEUR DU BORD - 3,5 CM**

Dimensions			Code	Robinetterie + finition baignoire				Choix des tabliers			
Cm	H	litres		Vidage sans robinetterie Blanc brillant    Blanc mat		Remplissage par le vidage Blanc brillant    Blanc mat		Robinetterie bord de baignoire Blanc brillant    Blanc mat		Sans Tabliers	Avec Tabliers

STANDARD À ENCASTRER AVEC PIEDS				-A	-U	1-A0K	1-U0K	2-A0K	2-U0K		
160 x 70	63	250	<b>DIF16970</b>								
170 x 70	63	280	<b>DIF17970</b>								
170 x 75	63	300	<b>DIF17975</b>								
180 x 80	63	350	<b>DIF18980</b>								
180 x 100	63	430	<b>DIF18910</b>								
190 x 90	63	420	<b>DIF19990</b>								

STANDARD - AVEC CHÂSSIS				-A	-U	1-A	1-U	2-A	2-U	0K	* Voir tableau <b>NOMBRE +                  FINITIONS                  DE TABLIERS</b>
160 x 70	63	250	<b>DI216970</b>								
170 x 70	63	280	<b>DI217970</b>								
170 x 75	63	300	<b>DI217975</b>								
180 x 80	63	350	<b>DI218980</b>								
180 x 100	63	430	<b>DI218910</b>								

HYDRO AIR (MASSAGE AIR AIRPOOL) - AVEC CHÂSSIS				0-A	0-U	1-A	1-U	2-A	2-U	0K	* Voir tableau <b>NOMBRE +                  FINITIONS                  DE TABLIERS</b>
160 x 70	63	250	<b>DIY169700</b>								
170 x 70	63	280	<b>DIY179700</b>								
170 x 75	63	300	<b>DIY179750</b>								
180 x 80	63	350	<b>DIY189800</b>								
180 x 100	63	430	<b>DIY189100</b>								

WHIRLPOOL (MASSAGE EAU WHIRLPOOL) - AVEC CHÂSSIS				0-A	0-U	1-A	1-U	2-A	2-U	0K	* Voir tableau <b>NOMBRE +                  FINITIONS                  DE TABLIERS</b>
160 x 70	63	250	<b>DI5169700</b>								
170 x 70	63	280	<b>DI5179700</b>								
170 x 75	63	300	<b>DI5179750</b>								
180 x 80	63	350	<b>DI5189800</b>								
180 x 100	63	430	<b>DI5189100</b>								

HYDRO PLUS (MASSAGE AIR AIRPOOL ET EAU WHIRLPOOL) - AVEC CHÂSSIS				0-A	0-U	1-A	1-U	2-A	2-U	0K	* Voir tableau <b>NOMBRE +                  FINITIONS                  DE TABLIERS</b>
160 x 70	63	250	<b>DI4169700</b>								
170 x 70	63	280	<b>DI4179700</b>								
170 x 75	63	300	<b>DI4179750</b>								
180 x 80	63	350	<b>DI4189800</b>								
180 x 100	63	430	<b>DI4189100</b>								



Dimensions			Code	Robinetterie + finition baignoire				Choix des tabliers	
<b>Cm</b>	<b>H</b>	<b>litres</b>							
				Blanc brillant    Blanc mat	Blanc brillant    Blanc mat	Blanc brillant    Blanc mat			

NATURAL AIR (SOIN MICRO-BULLES D'AIR) - AVEC CHÂSSIS											
				0-A	0-U	1-A	1-U	2-A	2-U	0K	* Voir tableau NOMBRE + FINITIONS DE TABLIERS
160 x 70	63	250	<b>DIN169700</b>								
170 x 70	63	280	<b>DIN179700</b>								
170 x 75	63	300	<b>DIN179750</b>								
180 x 80	63	350	<b>DIN189800</b>								
180 x 100	63	430	<b>DIN189100</b>								
190 x 90	63	420	<b>DIN199900</b>								

NATURAL AIR + WHIRLPOOL (SOIN MICRO-BULLES D'AIR ET MASSAGE EAU WHIRLPOOL) - AVEC CHÂSSIS											
				0-A	0-U	1-A	1-U	2-A	2-U	0K	* Voir tableau NOMBRE + FINITIONS DE TABLIERS
160 x 70	63	250	<b>DIP169700</b>								
170 x 70	63	280	<b>DIP179700</b>								
170 x 75	63	300	<b>DIP179750</b>								
180 x 80	63	350	<b>DIP189800</b>								
180 x 100	63	430	<b>DIP189100</b>								
190 x 90	63	420	<b>DIP199900</b>								





NOMBRE DE TABLIERS				Finitions tabliers / prix					
				ASSORTI À LA BAIGNOIRE		BOIS			
1 tablier de face	1 tablier de face + 1 tablier latéral	1 tablier de face + 2 tabliers latéraux	2 tabliers de face + 2 tabliers latéraux	Blanc brillant	Blanc mat	Blanc wood	Grain	Burlington	Wenge
<b>1</b>	<b>2</b>	<b>3</b>	<b>4</b>	<b>A</b>	<b>U</b>	<b>I</b>	<b>M</b>	<b>N</b>	<b>V</b>
	-	-	-						
-		-	-						
-	-		-						
-	-	-							

Composition du code de la baignoire **sans tabliers**    Code + Robinetterie + Finition baignoire + Sans tabliers (0K) = Code produit complet

Composition du code de la baignoire **avec tabliers**    Code + Robinetterie + Finition baignoire + Nombre de tabliers+Finitions tabliers (ASSORTI ou BOIS) = Code produit complet



**POUR LA VERSION AVEC TABLIERS ARGILE OU TABLIERS AVEC ENCADREMENT FRAME, COMMANDER : 1 CODE BAIGNOIRE SANS TABLIERS + 1 CODE TABLIERS (CI-DESSOUS)**

Dimensions	NOMBRE DE TABLIERS 	Finitions tabliers / prix															
		ARGILE			CADRE NOIR MAT						CADRE BLANC MAT						
					BOIS				ARGILE		BOIS			ARGILE			
		Pece	Polvere	Tortora	Blanc mat	Blanc wood	Grain	Burlington	Pece	Polvere	Tortora	Blanc wood	Grain	Burlington	Pece	Polvere	Tortora
<b>1</b>	<b>G</b>	<b>O</b>	<b>S</b>	<b>HU</b>	<b>HI</b>	<b>HM</b>	<b>HN</b>	<b>HG</b>	<b>HO</b>	<b>HS</b>	<b>UI</b>	<b>UM</b>	<b>UN</b>	<b>UG</b>	<b>UO</b>	<b>US</b>	
160 x 70	<b>PANV1FDI169-</b>																
170 x 70; 170 x 75	<b>PANV1FDI179-</b>																
180 x 80; 180 x 100	<b>PANV1FDI189-</b>																
190 x 90	<b>PANV1FDI199-</b>																
																	
	1 tablier de face + 1 tablier latéral																
	<b>2</b>	<b>G</b>	<b>O</b>	<b>S</b>	<b>HU</b>	<b>HI</b>	<b>HM</b>	<b>HN</b>	<b>HG</b>	<b>HO</b>	<b>HS</b>	<b>UI</b>	<b>UM</b>	<b>UN</b>	<b>UG</b>	<b>UO</b>	<b>US</b>
160 x 70	<b>PANV1F1LDI16970-</b>																
170 x 70	<b>PANV1F1LDI17970-</b>																
170 x 75	<b>PANV1F1LDI17975-</b>																
180 x 80	<b>PANV1F1LDI18980-</b>																
180 x 100	<b>PANV1F1LDI18910-</b>																
190 x 90	<b>PANV1F1LDI19990-</b>																
																	
	1 tablier de face + 2 tabliers latéraux																
	<b>3</b>	<b>G</b>	<b>O</b>	<b>S</b>	<b>HU</b>	<b>HI</b>	<b>HM</b>	<b>HN</b>	<b>HG</b>	<b>HO</b>	<b>HS</b>	<b>UI</b>	<b>UM</b>	<b>UN</b>	<b>UG</b>	<b>UO</b>	<b>US</b>
160 x 70	<b>PANV1F2LDI16970-</b>																
170 x 70	<b>PANV1F2LDI17970-</b>																
170 x 75	<b>PANV1F2LDI17975-</b>																
180 x 80	<b>PANV1F2LDI18980-</b>																
180 x 100	<b>PANV1F2LDI18910-</b>																
190 x 90	<b>PANV1F2LDI19990-</b>																
																	
	2 tabliers de face + 2 tabliers latéraux																
	<b>4</b>	<b>G</b>	<b>O</b>	<b>S</b>	<b>HU</b>	<b>HI</b>	<b>HM</b>	<b>HN</b>	<b>HG</b>	<b>HO</b>	<b>HS</b>	<b>UI</b>	<b>UM</b>	<b>UN</b>	<b>UG</b>	<b>UO</b>	<b>US</b>
160 x 70	<b>PANV2F2LDI16970-</b>																
170 x 70	<b>PANV2F2LDI17970-</b>																
170 x 75	<b>PANV2F2LDI17975-</b>																
180 x 80	<b>PANV2F2LDI18980-</b>																
180 x 100	<b>PANV2F2LDI18910-</b>																
190 x 90	<b>PANV2F2LDI19990-</b>																

**LE CADRE MÉTAL SE TROUVE SUR LES TABLIERS DE FACE**

**LES TABLIERS FRAME SONT DISPONIBLES AVEC LA BAIGNOIRE DIVINA 35 UNIQUEMENT**

# DIVINA

## BAIGNOIRE RECTANGULAIRE, FINITION BLANC BRILLANT OU BLANC MAT, FOND LISSE

Design Massimo Farinatti

Configurez votre baignoire sur [novellini.fr/yourproduct.html](http://novellini.fr/yourproduct.html)

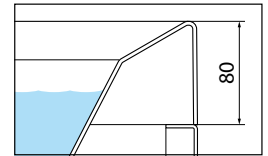

HAUTEUR DU BORD - 8 CM

Dimensions			Code	Robinetterie + finition baignoire				Choix des tabliers	
Cm	H	litres		Vidage sans robinetterie		Remplissage par le vidage		Robinetterie bord de baignoire	
				Blanc brillant	Blanc mat	Blanc brillant	Blanc mat	Blanc brillant	Blanc mat

STANDARD À ENCASTRER AVEC PIEDS									
				-A	-U	1-A0K	1-U0K	2-A0K	2-U0K
160 x 70	63	250	<b>DIF16070</b>						
170 x 70	63	280	<b>DIF17070</b>						
170 x 75	63	300	<b>DIF17075</b>						
180 x 80	63	350	<b>DIF18080</b>						
180 x 100	63	430	<b>DIF18010</b>						
190 x 90	63	420	<b>DIF19090</b>						

STANDARD - AVEC CHÂSSIS										
				-A	-U	1-A	1-U	2-A	2-U	0K
160 x 70	63	250	<b>DI216070</b>							
170 x 70	63	280	<b>DI217070</b>							
170 x 75	63	300	<b>DI217075</b>							
180 x 80	63	350	<b>DI218080</b>							
180 x 100	63	430	<b>DI218010</b>							
190 x 90	63	420	<b>DI219090</b>							

HYDRO AIR (MASSAGE AIR AIRPOOL) - AVEC CHÂSSIS										
				0-A	0-U	1-A	1-U	2-A	2-U	0K
160 x 70	63	250	<b>DIY160700</b>							
170 x 70	63	280	<b>DIY170700</b>							
170 x 75	63	300	<b>DIY170750</b>							
180 x 80	63	350	<b>DIY180800</b>							
180 x 100	63	430	<b>DIY180100</b>							
190 x 90	63	420	<b>DIY190900</b>							

WHIRLPOOL (MASSAGE EAU WHIRLPOOL) - AVEC CHÂSSIS										
				0-A	0-U	1-A	1-U	2-A	2-U	0K
160 x 70	63	250	<b>DI5160700</b>							
170 x 70	63	280	<b>DI5170700</b>							
170 x 75	63	300	<b>DI5170750</b>							
180 x 80	63	350	<b>DI5180800</b>							
180 x 100	63	430	<b>DI5180100</b>							
190 x 90	63	420	<b>DI5190900</b>							

HYDRO PLUS (MASSAGE AIR AIRPOOL ET EAU WHIRLPOOL) - AVEC CHÂSSIS										
				0-A	0-U	1-A	1-U	2-A	2-U	0K
160 x 70	63	250	<b>DI4160700</b>							
170 x 70	63	280	<b>DI4170700</b>							
170 x 75	63	300	<b>DI4170750</b>							
180 x 80	63	350	<b>DI4180800</b>							
180 x 100	63	430	<b>DI4180100</b>							
190 x 90	63	420	<b>DI4190900</b>							

NATURAL AIR (SOIN MICRO-BULLES D'AIR) - AVEC CHÂSSIS										
				0-A	0-U	1-A	1-U	2-A	2-U	0K
160 x 70	63	250	<b>DIN160700</b>							
170 x 70	63	280	<b>DIN170700</b>							
170 x 75	63	300	<b>DIN170750</b>							
180 x 80	63	350	<b>DIN180800</b>							
180 x 100	63	430	<b>DIN180100</b>							
190 x 90	63	420	<b>DIN190900</b>							



Dimensions			Code	Robinetterie + finition baignoire				Choix des tabliers	
Cm	H	litres		Vidage sans robinetterie Blanc brillant    Blanc mat		Remplissage par le vidage Blanc brillant    Blanc mat		Robinetterie bord de baignoire Blanc brillant    Blanc mat	
								Sans Tabliers	Avec Tabliers

NATURAL AIR + WHIRLPOOL (SOIN MICRO-BULLES D'AIR ET MASSAGE EAU WHIRLPOOL) - AVEC CHÂSSIS				0-A	0-U	1-A	1-U	2-A	2-U	0K	* Voir tableau NOMBRE + FINITIONS DE TABLIERS
160 x 70	63	250	DIP160700								
170 x 70	63	280	DIP170700								
170 x 75	63	300	DIP170750								
180 x 80	63	350	DIP180800								
180 x 100	63	430	DIP180100								
190 x 90	63	420	DIP190900								

NOMBRE DE TABLIERS				Finitions tabliers / prix					
				ASSORTI À LA BAIGNOIRE		BOIS			
1 tablier de face	1 tablier de face + 1 tablier latéral	1 tablier de face + 2 tabliers latéraux	2 tabliers de face + 2 tabliers latéraux	Blanc brillant	Blanc mat	Blanc wood	Grain	Burlington	Wenge
1	2	3	4	A	U	I	M	N	V
	-	-	-						
-		-	-						
-	-		-						
-	-	-							

Composition du code de la baignoire **sans tabliers** : Code + Robinetterie + Finition baignoire + Sans tabliers (0K) = Code produit complet

Composition du code de la baignoire **avec tabliers** : Code + Robinetterie + Finition baignoire + Nombre de tabliers+Finitions tabliers (ASSORTI ou BOIS) = Code produit complet

**POUR LA VERSION AVEC TABLIERS ARGILE, COMMANDER : 1 CODE BAIGNOIRE SANS TABLIERS + 1 CODE TABLIERS (CI-DESSOUS)**

Dimensions	NOMBRE DE TABLIERS				ARGILE		
					Pece	Polvere	Tortora
					G	O	S
160 x 70	PANV1FDI160-	-	-	-			
170 x 70; 170 x 75	PANV1FDI170-	-	-	-			
180 x 80; 180 x 100	PANV1FDI180-	-	-	-			
190 x 90	PANV1FDI190-	-	-	-			
160 x 70	-	PANV1F1LDI16070-	-	-			
170 x 70	-	PANV1F1LDI17070-	-	-			
170 x 75	-	PANV1F1LDI17075-	-	-			
180 x 80	-	PANV1F1LDI18080-	-	-			
180 x 100	-	PANV1F1LDI18010-	-	-			
190 x 90	-	PANV1F1LDI19090-	-	-			
160 x 70	-	-	PANV1F2LDI16070-	-			
170 x 70	-	-	PANV1F2LDI17070-	-			
170 x 75	-	-	PANV1F2LDI17075-	-			
180 x 80	-	-	PANV1F2LDI18080-	-			
180 x 100	-	-	PANV1F2LDI18010-	-			
190 x 90	-	-	PANV1F2LDI19090-	-			
160 x 70	-	-	-	PANV2F2LDI16070-			
170 x 70	-	-	-	PANV2F2LDI17070-			
170 x 75	-	-	-	PANV2F2LDI17075-			
180 x 80	-	-	-	PANV2F2LDI18080-			
180 x 100	-	-	-	PANV2F2LDI18010-			
190 x 90	-	-	-	PANV2F2LDI19090-			

**TUYAU ANTI-GOUTTE POUR DOUCHETTE EN SÉRIE AVEC LES BAIGNOIRES ÉQUIPÉES DE ROBINETTERIE**



BAIGNOIRE BLANC MAT AVEC TABLIERS ARGILE TORTORA



BAIGNOIRE BLANC MAT AVEC TABLIERS BURLINGTON ET CADRE BLANC MAT

## DIVINA | FINITIONS

### BAIGNOIRE ET TABLIERS



Blanc brillant Blanc mat

### TABLIERS FINITION BOIS

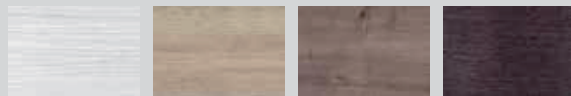

Blanc wood Grain Burlington Wenge

### TABLIERS FINITION ARGILE

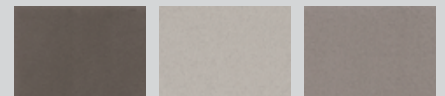

Pece Polvere Tortora

### CADRE ALUMINIUM NOIR MAT (DISPONIBLE UNIQUEMENT AVEC DIVINA 35)



Blanc mat Blanc wood Grain Burlington

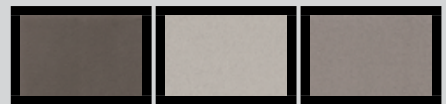

Pece Polvere Tortora

### CADRE ALUMINIUM BLANC MAT (DISPONIBLE UNIQUEMENT AVEC DIVINA 35)

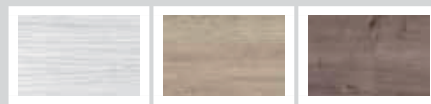

Blanc wood Grain Burlington

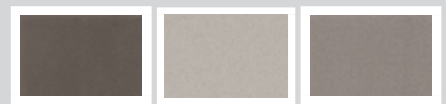

Pece Polvere Tortora

## DIVINA | FONCTIONS ET EQUIPEMENTS (disponibles en fonction de la version)

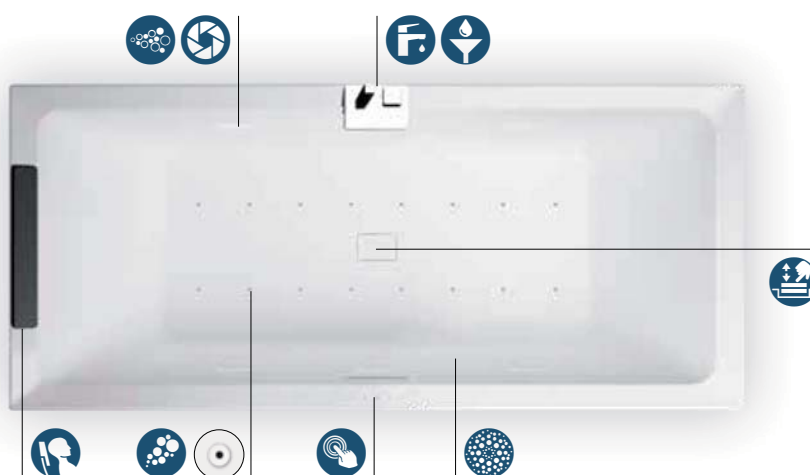

**Massage Airpool (16 jets)** à jet d'air constant ou intermittent



**Massage du corps Whirpool (6 jets)** eau/air constant ou à intensité variable



**Natural Air** diffusion de micro-bulles d'air enveloppantes et régénérantes



**Chromolight** avec variations de couleurs pour éveiller les émotions



**Commande tactile sensitive Soft Touch**



**Repose-tête** en matière antibactérienne



**Robinetterie bord de baignoire** débit constant, température variable, avec bec-cascade et douchette avec tuyau anti-goutte



**Vidage automatique** avec bonde clic-clac.

## OPTIONS POUR BAIGNOIRES

**REPOSE-TÊTE EN EVA\***  
pour Divina et Divina O



Code	Prix
<b>POGDIV</b>	

**REPOSE-TÊTE EN EVA\***  
pour Divina C



Code	Prix

**REPOSE-TÊTE EN EVA\***  
pour Iris version en niche



Code	Prix
<b>POGIRIN</b>	

NE PEUT ÊTRE UTILISÉ COMME SIÈGE

**REPOSE-TÊTE EN EVA\***  
pour Calos 2.0



Code	Prix
<b>POGCA1</b>	

**REPOSE-TÊTE EN EVA\***  
pour Calypso



Code	Prix
<b>POGCAL</b>	

**REPOSE-TÊTE EN EVA\***  
pour Vogue



Code	Prix

**ÉTAGÈRE PORTE-OBJET  
BORD DE BAIGNOIRE**  
pour Divina, Divina C, O et F



Code	Prix
<b>R90PODIV</b>	

**PLATEAU PORTE-OBJET SUR  
BAIGNOIRE**  
pour Divina et Divina F



Largeur	Code	Prix
70 cm	<b>R90VADIV70</b>	
75 cm	<b>R90VADIV75</b>	
80 cm	<b>R90VADIV80</b>	
90 cm	<b>R90VADIV90</b>	

**PROFILÉ DE FINITION RIGIDE**



Dimensions	Code	Prix
1 côté 185 cm	<b>PRV185-30</b>	
2 côtés 185x85 cm	<b>PRV18585-30</b>	
3 côtés 85x185x85 cm	<b>PRV8518585-30</b>	

\*EVA matière étanche et antibactérienne



## OPTIONS POUR BAIGNOIRES

### PROFILÉ DE FINITION I. 400 cm



Code	Prix
<b>PRVA2-A</b>	

### KIT 2 PROFILÉS DE FINITION RIGIDES EN PLASTIQUE



Code	Prix
<b>PRVA195-30</b>	

### TUYAU ANTI-GOUTTE



Code	Prix
<b>R90SCDOCBV</b>	

SENSE 7, IRIS, CALOS 2.0, UNA, VOGUE, VENUS, CALYPSO

### VIDAGE AUTOMATIQUE SANS REMPLISSAGE



Code	Prix
<b>COLSCAVK-K</b>	

### VIDAGE AUTOMATIQUE AVEC REMPLISSAGE



Code	Prix
<b>COLSCAE-K</b>	

### TRAPPE DE VISITE POUR BAIGNOIRE À ENCASTRER 60x33x2 cm



SENSE

Code	Prix
<b>PANISPEL-A</b>	

IRIS, CALOS 2.0, UNA, VOGUE, VENUS, CALYPSO, BABY

Code	Prix
<b>PANISP-A</b>	

### KIT 4 PIEDS RÉGLABLES POUR BAIGNOIRES À ENCASTRER pour Sense, Iris, Calos 2.0



Code	Prix
<b>PIEDVASCA</b>	

### KIT 4 PIEDS RÉGLABLES pour Divina, Calos 2.0, Una, Vogue, Venus, Calypso



Code	Prix
<b>PIEDVASCA70</b>	
<b>PIEDVASCA75</b>	
<b>PIEDVASCA80</b>	
<b>PIEDVASCA90</b>	
<b>PIEDVASCA100</b>	

### KIT PARE-BAIGNOIRE DIVINA



Pour la baignoire Divina rectangulaire :

**1 pare-baignoire Young 1V**  
**1 kit d'adaptation**

voir pages 580, 582



# KIT HYDROSILENCE



## DIVINA DUAL

Dimensions	Tabliers	Code	Prix
190 x 140	1 Tablier	<b>KUSDIV1F19014</b>	
190 x 140	2 Tabliers	<b>KUSDIV1FL19014</b>	
190 x 140	3 Tabliers	<b>KUSDIV1F2L19014</b>	
190 x 140	4 Tabliers	<b>KUSDIV2F2L19014</b>	

## DIVINA C

Dimensions	Tablier	Code	Prix
140 x 140	1 Tablier	<b>KUSDIVC</b>	

## DIVINA O

Dimensions	Tablier	Code	Prix
165 X 98	1 Tablier	<b>KUSDIVO</b>	

## DIVINA 160/170

Dimensions	Tabliers	Code	Prix
160/170	4 Tabliers	<b>KUSDIV2F2L160</b>	

## DIVINA 180/190

Dimensions	Tabliers	Code	Prix
180/190	4 Tabliers	<b>KUSDIV2F2L190</b>	

## DIVINA - SENSE 3-4

Tabliers	Code	Prix
3 Tabliers	<b>KUSDIV1F2L</b>	

## DIVINA - SENSE 3-4 ANGLE

Tabliers	Code	Prix
2 Tabliers	<b>KUSDIV1F1L</b>	

## DIVINA - SENSE 3-4 EN NICHE

Tablier	Code	Prix
1 Tablier	<b>KUSDIV1F</b>	

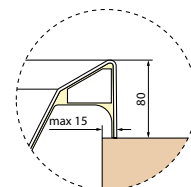
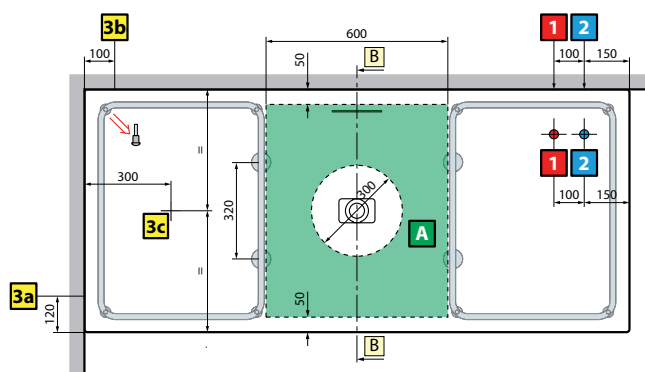
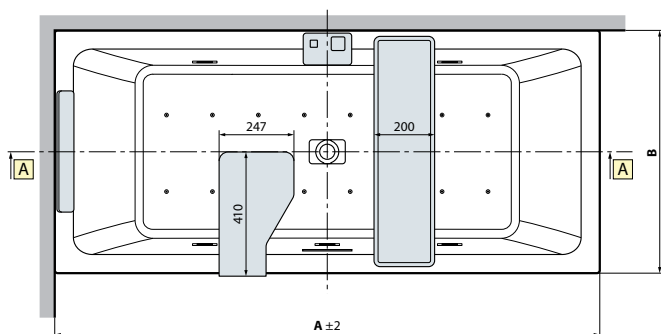
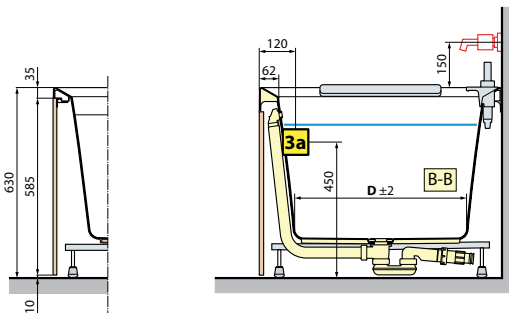
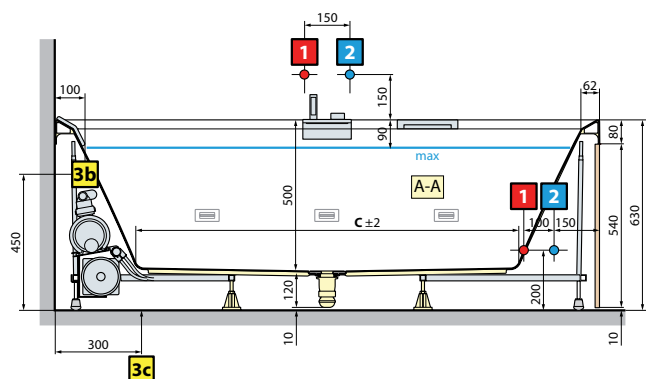

modèle	A	B	C	D	Capacité litres
<b>160x70</b>	1600	700	1050	460	250
<b>170x70</b>	1700	700	1150	460	280
<b>170x75</b>	1700	750	1150	510	300
<b>180x80</b>	1800	800	1250	560	350
<b>180x100</b>	1800	1000	1250	760	430
<b>190x90</b>	1900	900	1350	660	420

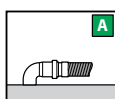

**CARACTÉRISTIQUES HYDRAULIQUES**

16 jets Airpool  
6 jets whirlpool  
Siphon 1 1/2"

**CARACTÉRISTIQUES ÉLECTRIQUES**

220-230 V  
50 Hz  
Absorption maximale:  
Whirlpool: 900 W  
Airpool: 400 W  
Plus: 1300 W  
Natural Air: 1050 W

En amont de l'appareil, installer un disjoncteur différentiel de 30 mA et un coupe-circuit magnétothermique à déconnexion omnipolaire distance d'ouverture ≥ 3 mm.

